

TOLERANCE	
<6	±0.1mm
<6~30	±0.15mm
>30	±0.2mm
-	-
-	-
X'	±10°
-	-

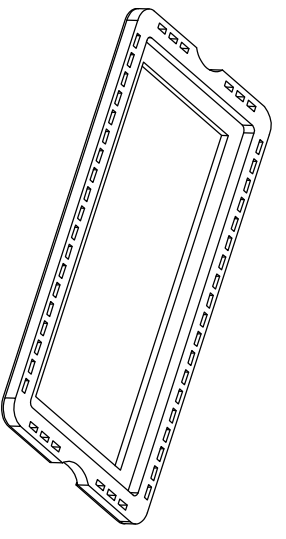

盖板

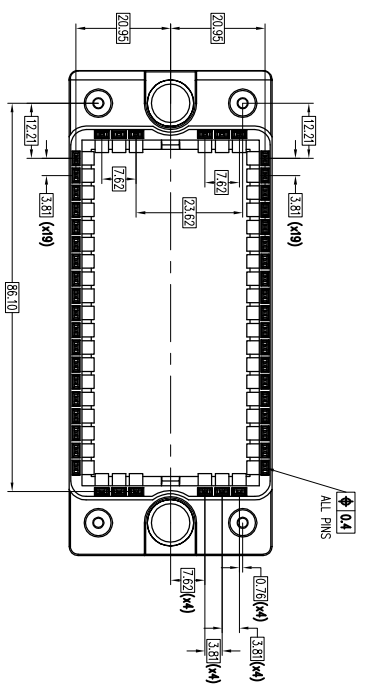
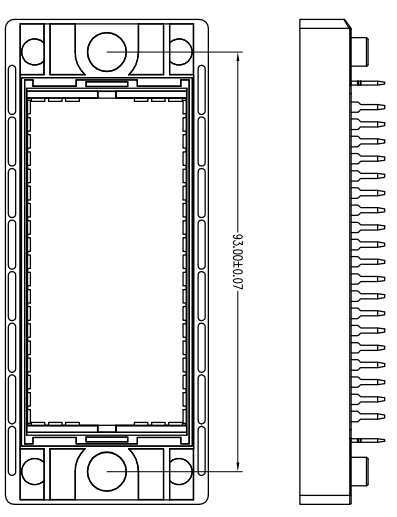
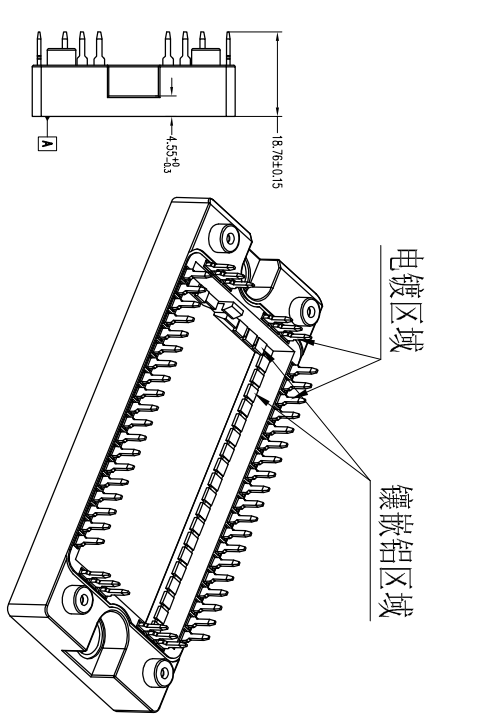
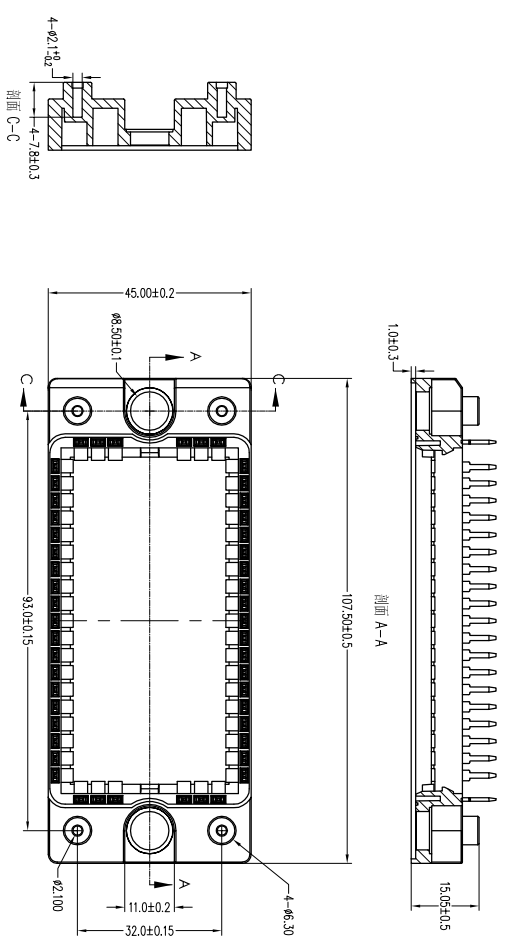
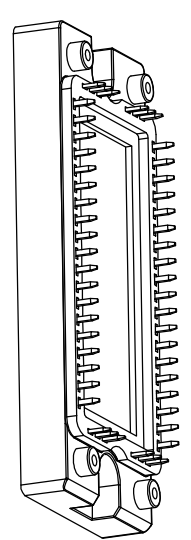

加盖后产品

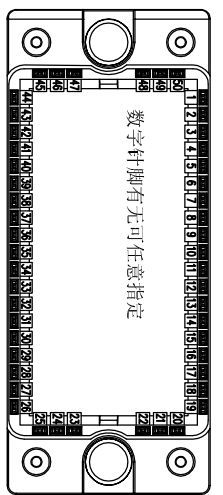

- 技术要求:
1. 塑料材质为PBT+30%玻纤;
  2. 金属材料为铜覆铝; 基材C10300或C10200;
  3. 铜材选择性电镀-5um 镍打底, 再镀2-5um 亮锡;

A	Original Edition	Awn	2018-07-19
REV	DESCRIPTION	REV BY	DATE
PRODUCT NO.: WA1026 SERIES			
CHKD: -			
DR:	Awn Wang	SHEET SIZE	DWG NO.: 1026
		1/1	mm

ZH Weilain Electronic  
(Hangzhou) Co., Ltd